



YETDA INDUSTRY LTD.

0.4" DUAL DIGIT RED LED DISPLAY

D-4028ASK11

DESCRIPTION

- * 0.4" (10.2mm) Inch Digit Height.
- * High Bright Red Display.
- * Black Face and White Segment Color.
- * Common Anode.

ABSOLUT MAXIMUM RATINGS AT Ta=25°C

Parameter		UNIT
Power Dissipation Per Seg.	40	mW
Peak Forward Current Per Seg.	120	mA
Forward current Per Seg.	30	mA
Reverse Voltage Per Seg.	5	V
Operation Temperature Range	-25°C TO +80°C	°C
Storage Temperature Range	-25°C TO +100°C	°C
Lead Soldering Temperature	260°C for 3 seconds 1.6mm(1/16 inch) from body	

ELECTRICAL/OPTOTICAL CHARACTERISTIC AT Ta=25°C

PARAMETER	SYMBOL	MIN.	TYP.	MAX.	UNIT	CONDITION
Average Luminous Intensity	Iv	4	12		mcd	If=20mA
Emission Wavelength	λ d		660		nm	If=20mA
Forward Voltage Per Seg.	Vf		1.8	2.2	V	If=20mA
Reverse Current Per Seg.	Ir			10	uA	Vr=5V
Luminous Intensity Matching Ratio	Iv-m		2 : 1			If=20mA



YETDA INDUSTRY LTD.

P.C.B. Pin Connection

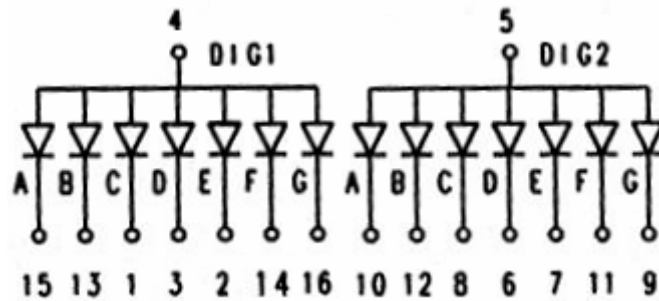

Reflector Dimensions

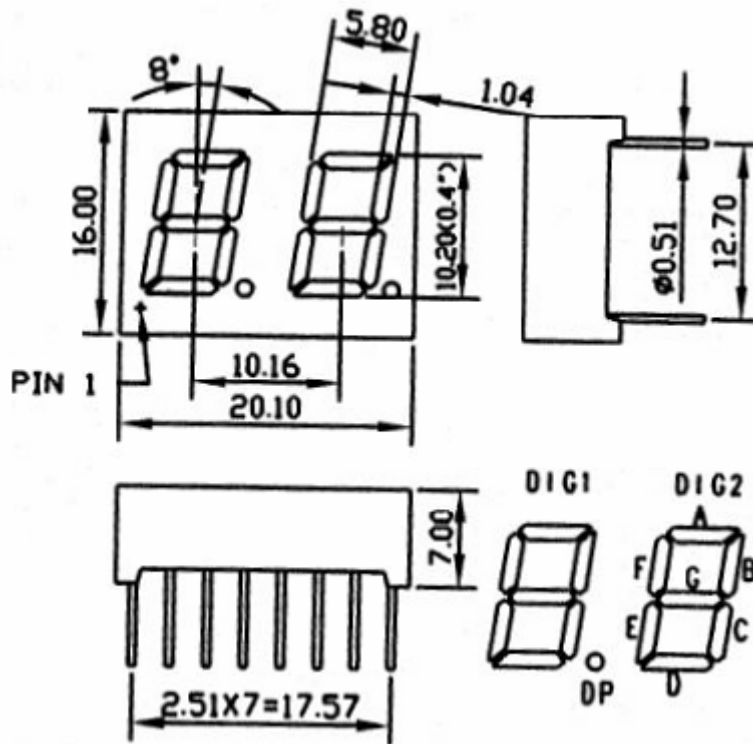

Unit:mm