



YETDA INDUSTRY LTD.

Technical Data Sheet

MODEL NO : Q110Y4

1204Package 3.2*1.5mm Chip LEDs

Features :

- Package in 8mm tape on 7" diameter reel
- Compatible with automatic placement equipment
- Compatible with reflow solder process

Applications :

- Indicators
- Automotive : backlighting in dashboard and switch
- Backlight for LCD

● Package Dimensions of Device

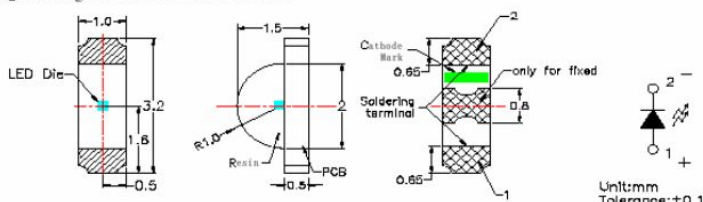

Dice material	Emitted color	Lens Color
AlGaInP	Yellow	Water Clear

Electrical/Optical Characteristics(Ta=25°C)

Parameter	Symbol	Condition	Min	Typ.	Max	Unit
Luminous Intensity	I _v	IF=20mA	60	90		mcd
Dominant Wavelength	λ _D	IF=20mA	584	590	593	nm
Peak Emission Wavelength	λ _p	IF=20mA		592		nm
Viewing Angle	2θ _{1/2}	IF=20mA		110		Deg
Forward Voltage	V _F	IF=20mA		2.0	2.4	V
Reverse Current	I _R	VR=5V			10	μA

Absolute Maximum Ratings(Ta=25°C)

Parameter	Symbol	Maximum	Unit
Power Dissipation	P _d	78	mW
Peak Forward Current(1/10 Duty Cycle 0.1ms Pulse Width)	IF(Peak)	100	mA
Continuous Forward Current	IF	30	mA
Reverse Voltage	VR	5	V
Derating Linear From 25°C		0.3	mA/°C
Operating Temperature Range	Topr	-30 to +80	°C
Storage Temperature Range	Tstg	-40 to +90	°C

20090727



YETDA INDUSTRY LTD.

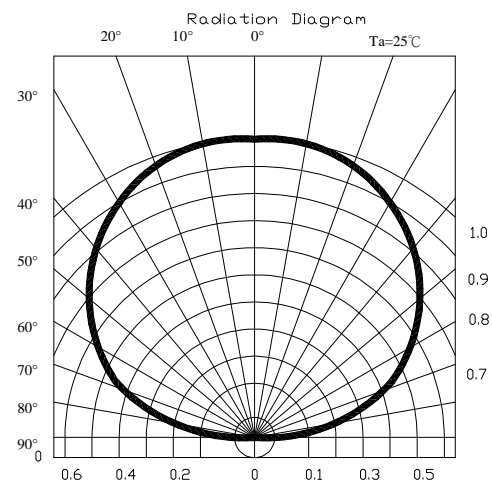
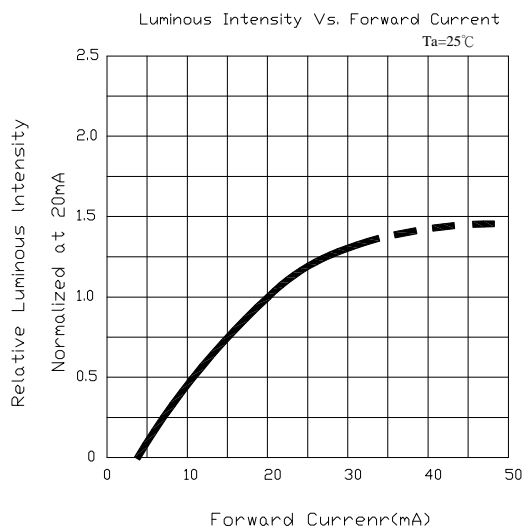
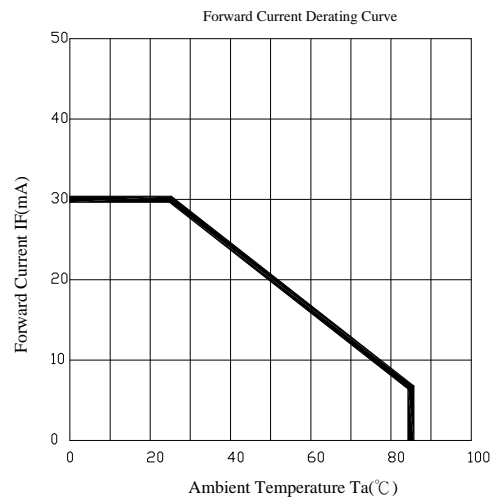
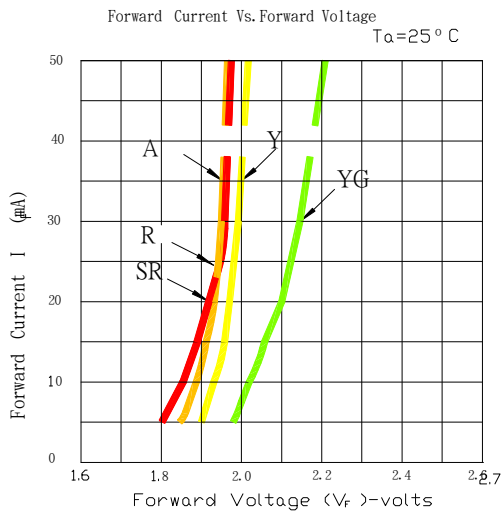
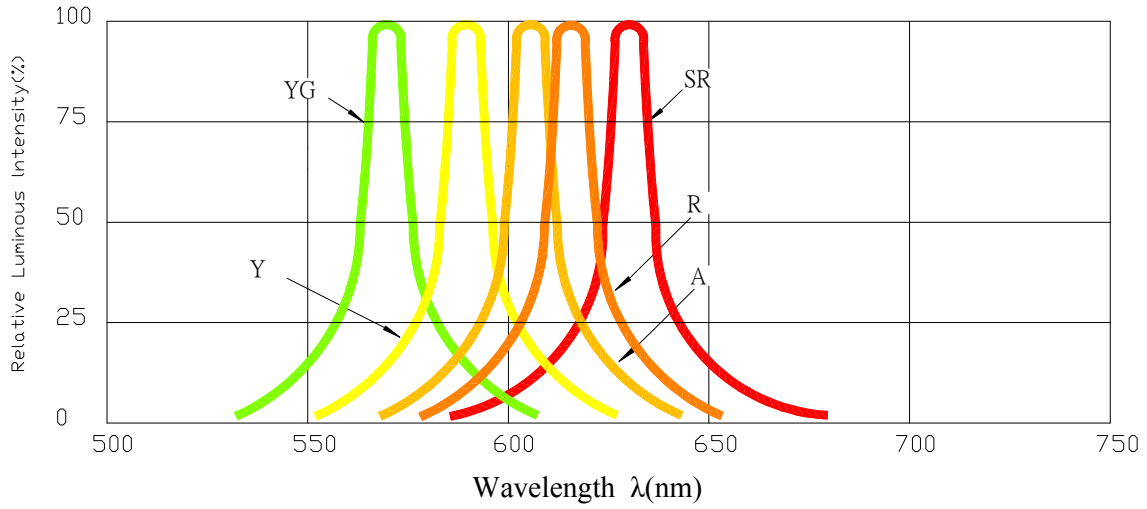



YETDA INDUSTRY LTD.

◆ Dimensions / Taping and Package Spec.

● Package Dimensions of Device

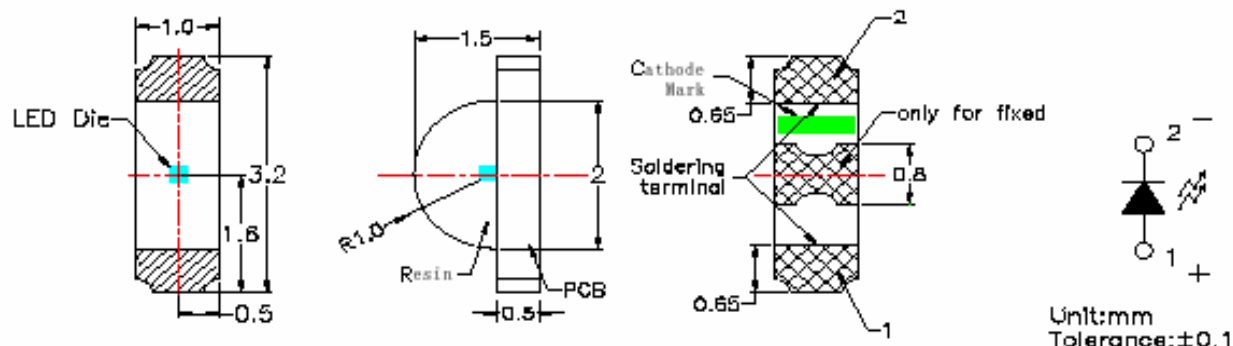

1. Soldering terminal may shift in x, y direction.

● Recommended Soldering Pad Dimensions

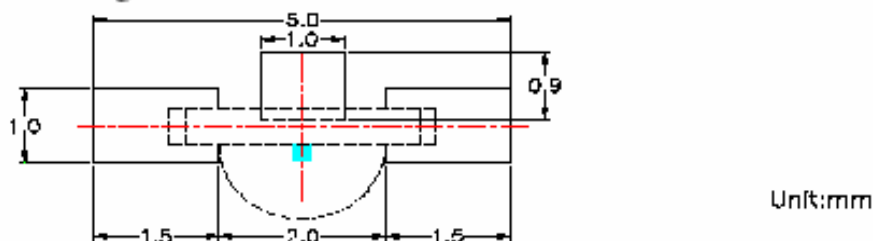

● Tape Specification : 3000pcs Per Reel

Packing Size													
Item	W	P1	E	F	D ₀	D1	P ₀	10P ₀	P2	A ₀	B ₀	K ₀	t
Spec.	8.00	4.00	1.75	3.50	1.50	1.00	4.00	40.00	2.00	1.75	3.40	1.25	0.23
Tolerance	±0.20	±0.10	±0.10	±0.05	$\begin{matrix} +0.10 \\ -0.05 \end{matrix}$	±0.05	±0.05	±0.20	±0.05	±0.10	±0.10	±0.10	±0.02

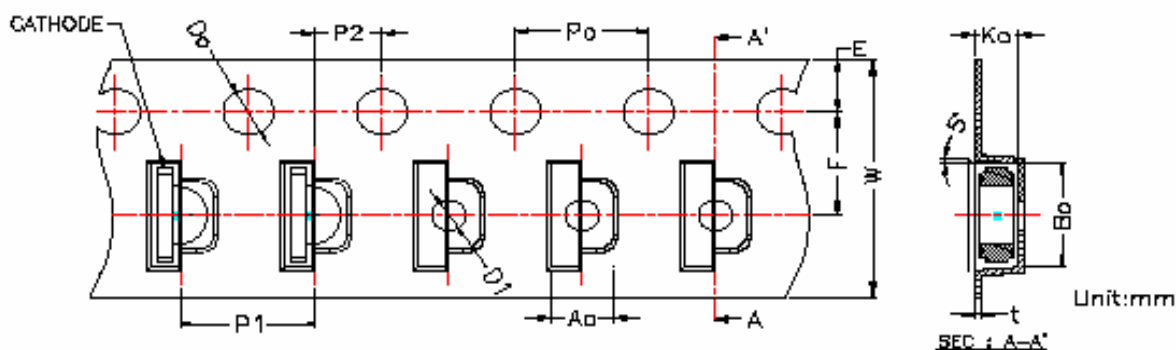

● Package Dimensions of Reel :

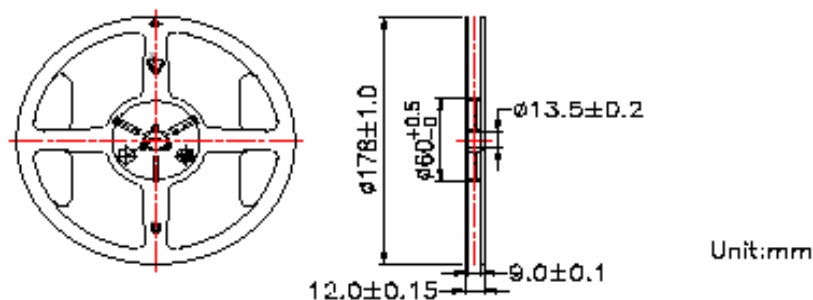



YETDA INDUSTRY LTD.

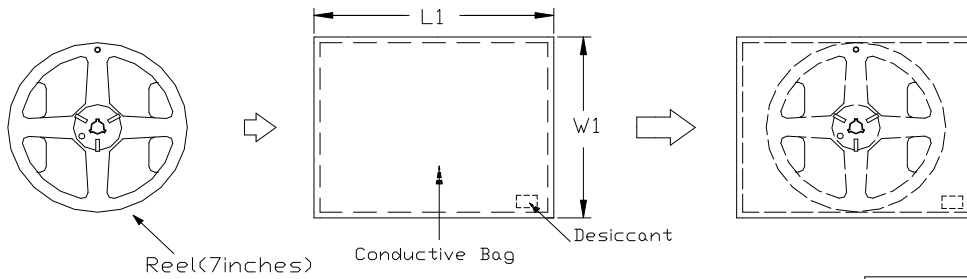

Dimension	L1	W1
Spec.	253	224

Unit : mm

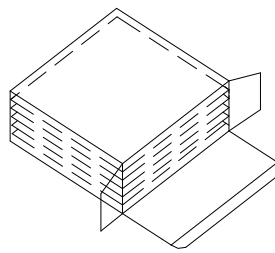
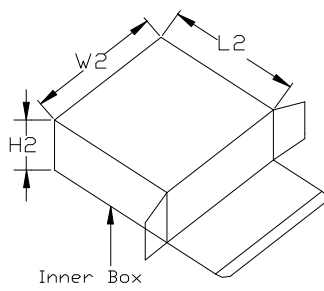

5 Reel per Box

Dimension	L2	W2	H2
Outside	220	190	60
Inside	219.5	189.5	59.5

Unit : mm

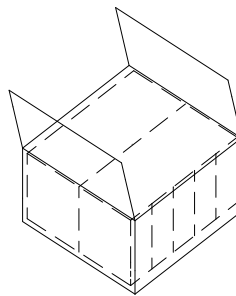
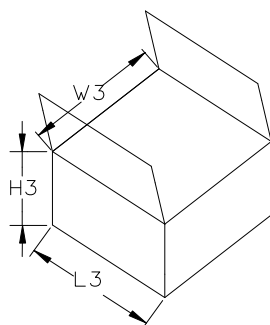

Dimension	L3	W3	H3
Outside	395	320	240
Inside	382	307	227

Unit : mm



YETDA INDUSTRY LTD.

● Descriptions :

- The Chip-LED Taping is much smaller than lead frame type components, thus enable smaller board size, higher packing density, reduced storage space and finally smaller equipment to be obtained.
- Besides, lightweight makes them ideal for miniature application, etc.

● Soldering heat reliability (DIP) :

Please refer to the following figure :

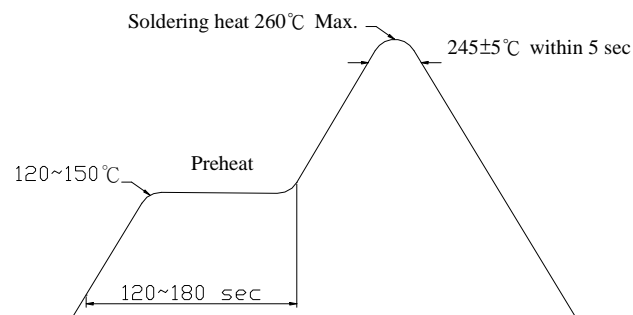

● Precautions For Use :

- Over - current - proof

Customer must apply resistors for protection, otherwise slight voltage shift will cause big current change (Burn out will happen)

- Storage

1. The operation of temperature and R.H. are : 5°C ~ 30°C , 60%R.H. Max..
2. Once the package is opened, the products should be used within a week. Otherwise, they should be kept in a dampproof box with desiccating reagent. Considering the tape life, we suggest our customers to use our products within 1.5 year (from production date) .
3. It's recommended to bake before soldering when the package is unsealed after 72 hrs. The condition is : 60°C±5°C for 15hrs.



● Test Circuit

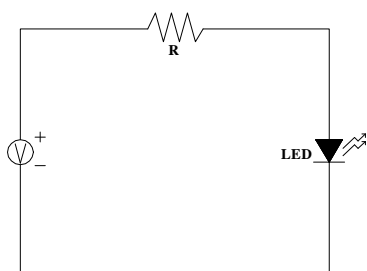

● Reflow Temp. / Time :

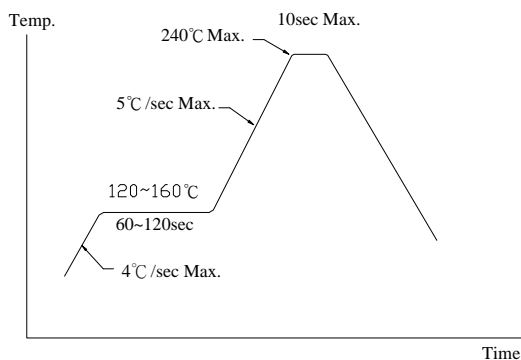

● Reliability Test Items And Conditions

The reliability of products shall be satisfied with items listed below.

No.	Items	Test Condition	Test Hours/Cycles	Sample Size
1	Solder Heat	TEMP : 260°C ±5°C	5 sec	48 pcs
2	Temperature Cycle	90°C ~ 25°C ~ -30°C ~ 25°C 30m 5m 30m 5m	300Cycles	48 Pcs
3	Thermal Shick	100°C ~ -55°C 10m 10m	100Cycles	48 Pcs
4	Operation Life	If=20mA	1000 Hrs	48 Pcs
5	High Temperature Storage	Temp:90°C	1000Hrs	48 Pcs
6	Low Temperature Storage	Temp:-30°C	1000Hrs	48 Pcs
7	High Temperature/High Humidity	80°C / R.H80%	1000Hrs	48 Pcs