



# YETDA INDUSTRY LTD.

## Technical Data Sheet

**MODEL NO : Q195R/R4**

**0605Package 1.6\*1.5mm Chip LEDs**

### Features :

- Package in 8mm tape on 7" diameter reel
- Compatible with automatic placement equipment
- Compatible with reflow solder process

### Applications :

- Indicators
- Automotive : backlighting in dashboard and switch
- Backlight for LCD

Dice material	Emitted color	Lens Color
AlGaInP/GaAs	Red	Water Clear

### Electrical/Optical Characteristics(Ta=25°C)

Parameter	Test Condition	Symbol	Value			Unit
			Min	Typ	Max	
Wavelength at peak emission	If=20mA	$\lambda$ peak		635		nm
Spectral half bandwidth	If=20mA	$\Delta \lambda$		25		nm
Dominant wavelength	If=20mA	$\lambda$ dom		625		nm
Forward voltage	If=20mA	Vf		2.0	2.4	V
Luminous intensity	If=20mA	Iv		80		mcd
Viewing angle at 50% Iv	If=10mA	2 $\theta$ 1/2		140		Deg
Reverse current	Vr=5V	Ir			10	$\mu$ A

### Absolute Maximum Ratings(Ta=25°C)

Parameter	Symbol	Value	Unit
Power dissipation	Pd	75	mW
Forward current	If	30	mA
Reverse voltage	Vr	5	V
Operating temperature range	Top	-40 ~+80	°C
Storage temperature range	Tstg	-40 ~+85	°C
Peak pulsing current (1/8 duty f=1kHz)	Ifp	125	mA



YETDA INDUSTRY LTD.

PACKAGING DIMENSIONS(Unit:mm):

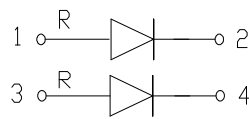
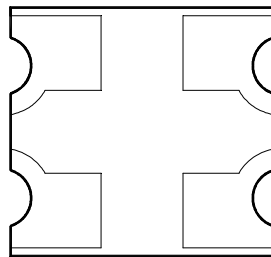
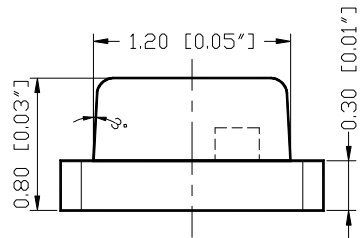
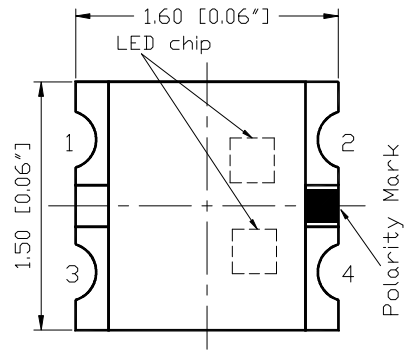



# YETDA INDUSTRY LTD.

Forward Current Vs. Forward Voltage

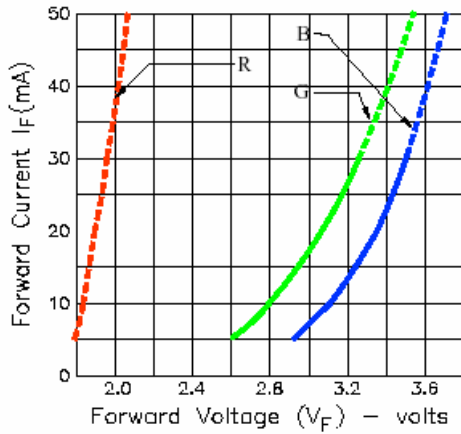

Luminous Intensity Vs. Forward Current

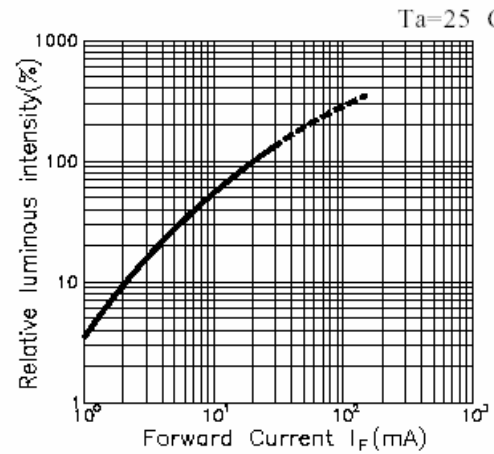

Forward Current Derating Curve

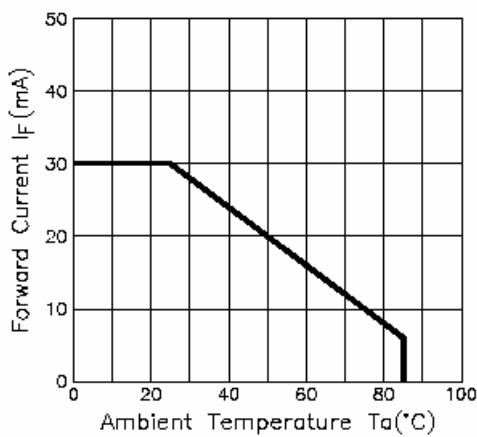

Radiation Diagram

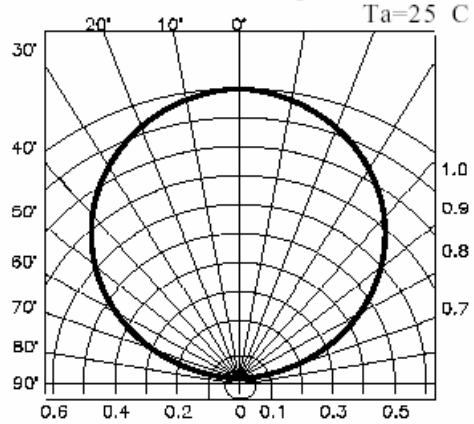

Spectrum Distribution

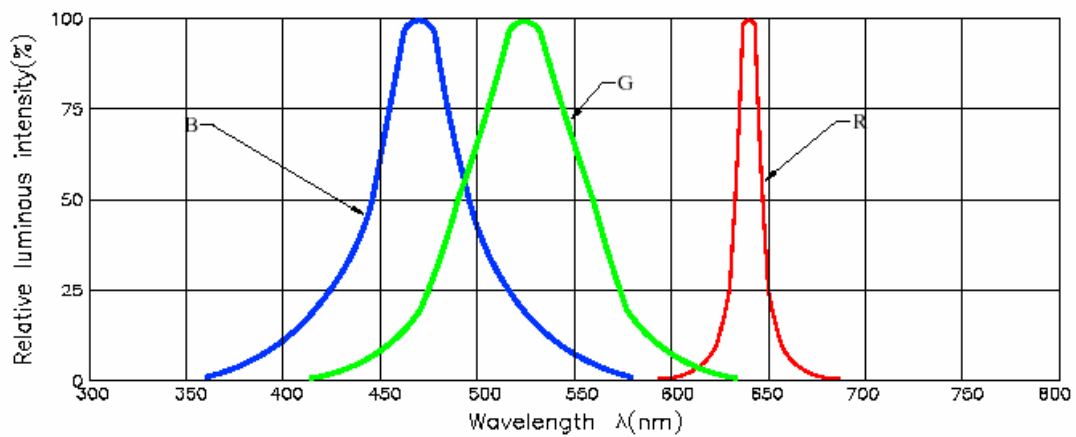



# YETDA INDUSTRY LTD.

Feeding Direction	Dimensions of Reel (Unit: mm)

Dimensions of Tape (Unit: mm)

Arrangement of Tape

NOTES
<ol style="list-style-type: none"> <li>1. Empty component pockets are sealed with top cover tape;</li> <li>2. The maximum number of missing lamps is two;</li> <li>3. The polarity mark is oriented towards the tape sprocket hole ;</li> <li>4. 4,000pcs/Reel.</li> </ol>



# YETDA INDUSTRY LTD.

## PACKAGING SPECIFICATIONS

### Packaging specifications

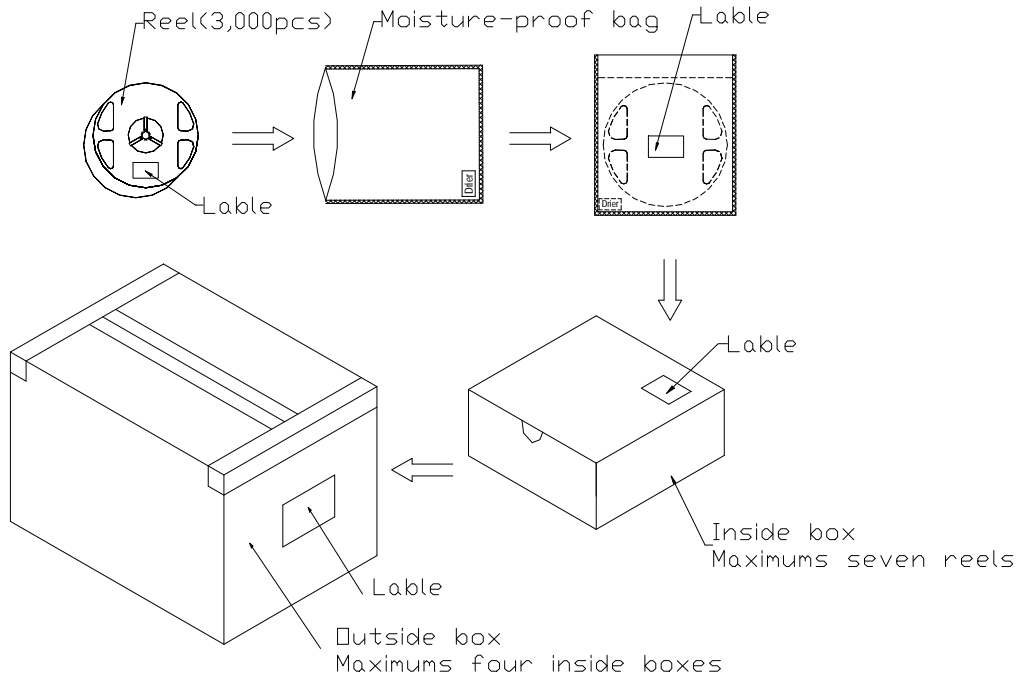

### NOTES:

Reeled products (numbers of products are 4,000pcs) packed in a seal off moisture-proof bag along with a desiccant one by one, Seven moisture-proof bag of maximums (total maximum number of products are 28,000pcs) packed in an inside box (size: about 283mm x about 194mm x about 102mm) and four inside boxes of maximums are put in the outside box (size: about 410mm x about 254mm x about 229mm) Together with buffer material, and it is packed. (Part No., Lot No., quantity should appear on the label on the moisture-proof bag, part No. And quantity should appear on the label on the cardboard box.) The number of the loading steps of outside box (cardboard box) has it to three steps.



# YETDA INDUSTRY LTD.

## Descriptions :

The Chip-LED Taping is much smaller than lead frame type components, thus enable smaller board size, higher packing density, reduced storage space and finally smaller equipment to be obtained.

Besides, lightweight makes them ideal for miniature application, etc.

## Soldering heat reliability (DIP) :

Please refer to the following figure :

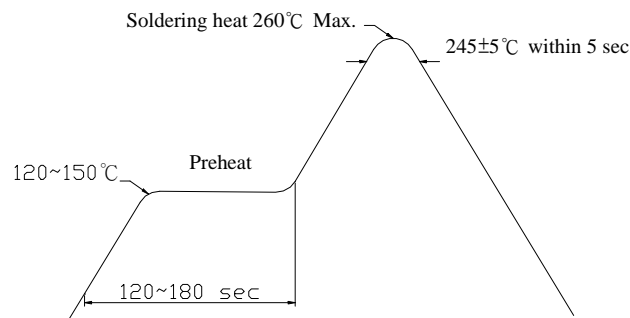

## Precautions For Use :

### Over - current - proof

Customer must apply resistors for protection, otherwise slight voltage shift will cause big current change ( Burn out will happen )

### Storage

1. The operation of temperature and R.H. are :  $5^{\circ}\text{C} \sim 30^{\circ}\text{C}$  , 60%R.H. Max.
2. Once the package is opened, the products should be used within a week. Otherwise, they should be kept in a dampproof box with desiccating regent. Considering the tape life, we suggest our customers to use our products within 1.5 year ( from production date ) .
3. It's recommended to bake before soldering when the package is unsealed after 72 hrs. The condition is :  $60^{\circ}\text{C} \pm 5^{\circ}\text{C}$  for 15hrs.



# YETDA INDUSTRY LTD.

## Test Circuit

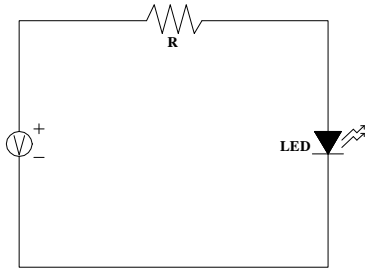

## Reflow Temp. / Time :

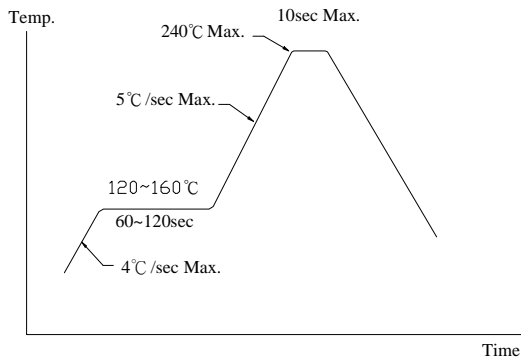

## Reliability Test Items And Conditions

The reliability of products shall be satisfied with items listed below.

No.	Items	Test Condition	Test Hours/Cycles	Sample Size
1	Solder Heat	TEMP : 260°C ±5°C	5 sec	48 pcs
2	Temperature Cycle	90°C ~ 25°C ~ -30°C ~ 25°C 30m 5m 30m 5m	300Cycles	48 Pcs
3	Thermal Shick	100°C ~ -55°C 10m 10m	100Cycles	48 Pcs
4	Operation Life	If=20mA	1000 Hrs	48 Pcs
5	High Temperature Storage	Temp:90°C	1000Hrs	48 Pcs
6	Low Temperature Storage	Temp:-30°C	1000Hrs	48 Pcs
7	High Temperature/High Humidity	80°C / R.H80%	1000Hrs	48 Pcs