



YETDA INDUSTRY LTD.

1.8" SINGLE DIGIT RED LED DISPLAY

S-18018AUF11

DESCRIPTION

- * 1.8" (45.00mm) Inch Digit Height.
- * Super Bright Red Display.
- * Black Face and White Segment Color.
- * Common Anode.

ABSOLUT MAXIMUM RATINGS AT Ta=25°C

Parameter		UNIT
Power Dissipation Per Seg.	120	mW
Power Dissipation Per Dot	40	
Peak Forward Current Per Seg. & Dot	120	mA
Forward current Per Seg. & Dot (Static)	30	mA
Reverse Voltage Per Seg.	15	V
Reverse Voltage Per Dot	5	
Operation Temperature Range	-25°C TO +80°C	°C
Storage Temperature Range	-25°C TO +100°C	°C
Lead Soldering Temperature	260 for 3 seconds 1.6mm(1/16 inch) from body	

ELECTRICAL/OPTOTICAL CHARACTERISTIC AT Ta=25°C

PARAMETER	SYMBOL	MIN.	TYP.	MAX.	UNIT	CONDITION
Average Luminous Intensity	Iv	50	60		mcd	If=20mA
Average Luminous Intensity	Iv	33	39		mcd	If=10mA
Emission Wavelength	d		625		nm	If=20mA
Forward Voltage Per Seg.	Vf		6.0	7.2	V	If=20mA
Forward Voltage Per Dot			2.0	2.4		
Reverse Current Per Seg.	Ir			10	uA	Vr=15V
Reverse Current Per Dot						Vr=5V
Luminous Intensity Matching Ratio	Iv-m		2 : 1			If=20mA



YETDA INDUSTRY LTD.

P.C.B. Pin Connection

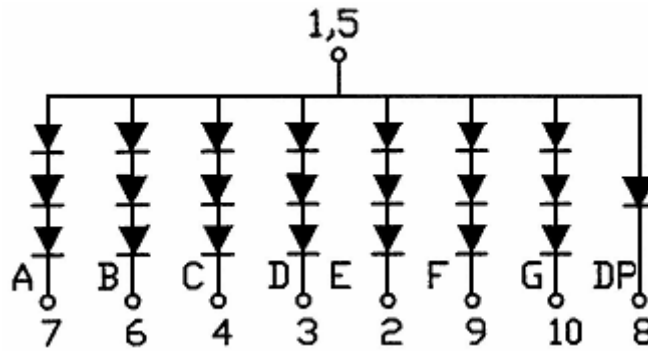

Reflector Dimensions

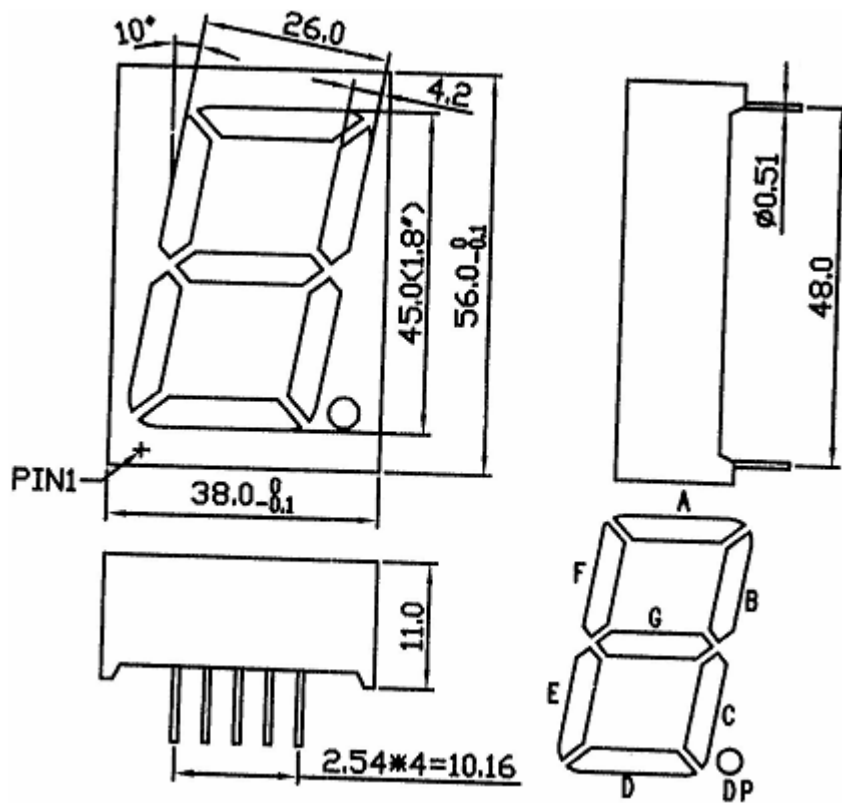

Unit:mm