



YETDA INDUSTRY LTD.

Technical Data Sheet

MODEL NO : S150ANG4-R

1206 Reverse Mounted SMD LEDs

Features :

- Package in 8mm tape on 7" diameter reel
- Compatible with automatic placement equipment
- Compatible with reflow solder process

Applications :

- Indicators
- Automotive : backlighting in dashboard and switch
- Backlight for LCD

Dice material	Emitted color	Lens Color
InGaN/GaN	Green	Water Clear

Electrical/Optical Characteristics(Ta=25°C)

Parameter	Test Condition	Symbol	Value			Unit
			Min	Typ	Max	
Spectral half bandwidth	I _F =20mA	$\Delta \lambda$		35		nm
Dominant wavelength	I _F =20mA	λ_D	516		526	nm
Forward voltage	I _F =20mA	V _F	2.8		3.6	V
Luminous intensity	I _F =20mA	I _v	250	450		mcd
Viewing angle at 50% I _v	I _F =10mA	2θ 1/2		120		Deg
Reverse current	V _R =5V	I _R			10	μA



YETDA INDUSTRY LTD.

Absolute Maximum Ratings(Ta=25°C)

Parameter	Symbol	Value	Unit
Power dissipation	Pd	108	mW
Forward current	I _F	30	mA
Reverse voltage	V _R	5	V
Operating temperature range	T _{op}	-40 ~+80	°C
Storage temperature range	T _{stg}	-40 ~+85	°C
Peak pulsing current (1/8 duty f=1kHz)	I _{FP}	125	mA

PACKAGING DIMENSIONS (mm):

Package outlines

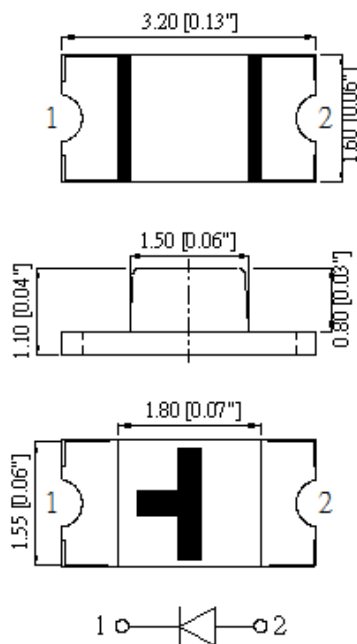

Recommend Pad Layout

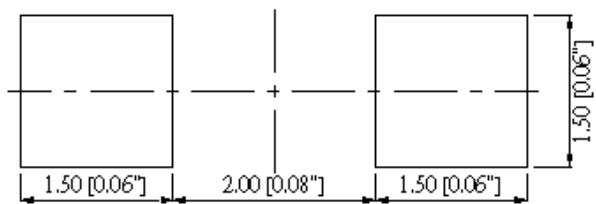

NOTES:

1. All dimensions are in millimeters (inches);
2. Tolerances are ± 0.1 mm (0.004inch) unless otherwise noted.



Typical Electro-Optical Characteristics Curve:

Fig 1. Forward Current vs. Forward Voltage

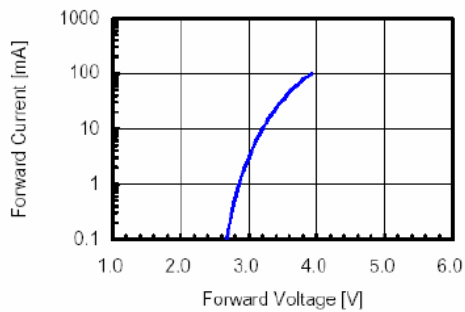

Fig 2. Relative Intensity vs. Forward Current

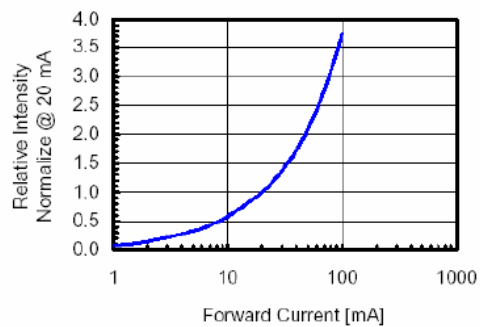

Fig 3. Forward Voltage vs. Temperature

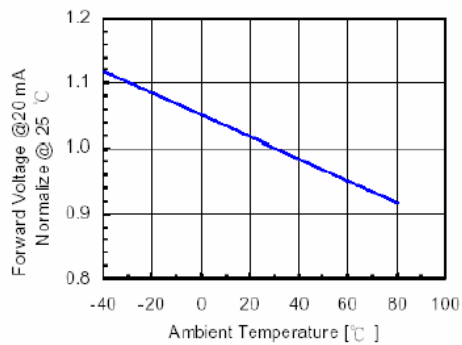

Fig 4. Relative Intensity vs. Temperature

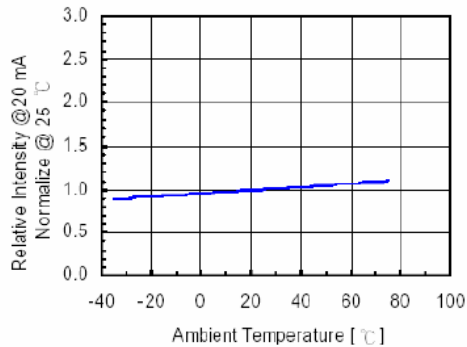
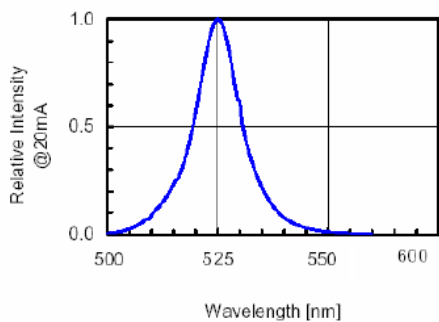

Fig 5. Relative Intensity vs. Wavelength





YETDA INDUSTRY LTD.

Precautions For Use :
Over - current - proof
Customer must apply resistors for protection, otherwise slight voltage shift will cause big current change (Burn out will happen)
Storage
1. The operation of temperature and R.H. are : $5^{\circ}\text{C} \sim 30^{\circ}\text{C}$, 60%R.H. Max.
2. Once the package is opened, the products should be used within a week. Otherwise, they should be kept in a dampproof box with desiccating reagent. Considering the tape life, we suggest our customers to use our products within 1.5 year (from production date) .
3. It's recommended to bake before soldering when the package is unsealed after 72 hrs. The condition is : $60^{\circ}\text{C} \pm 5^{\circ}\text{C}$ for 15hrs.

■ Reflow Temp/Time

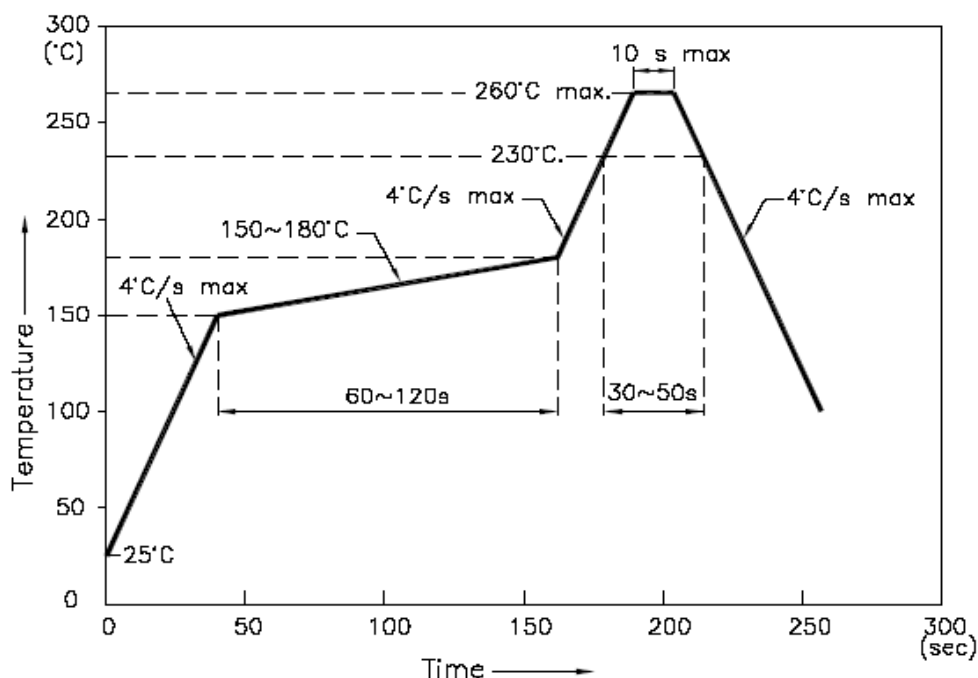

NOTES:

1. We recommend the reflow temperature $245^{\circ}\text{C} (\pm 5^{\circ}\text{C})$. the maximum soldering temperature should be limited to 260°C .
2. dont cause stress to the epoxy resin while it is exposed to high temperature.
3. Number of reflow process shall be 2 times or less.



YETDA INDUSTRY LTD.

■Soldering iron

Basic spec is $\leq 5\text{sec}$ when 260°C . If temperature is higher, time should be shorter ($+10^{\circ}\text{C} \rightarrow -1\text{sec}$). Power dissipation of iron should be smaller than 20W, and temperatures should be controllable. Surface temperature of the device should be under 230°C .

■Rework

1. Customer must finish rework within 5 sec under 260°C .
2. The head of iron can not touch copper foil
3. Twin-head type is preferred.

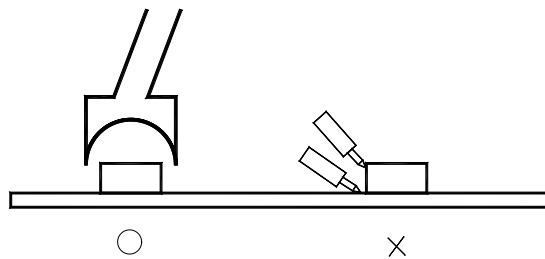

- Avoid rubbing or scraping the resin by any object, during high temperature, for example reflow 、 solder etc.

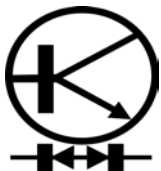

YETDA INDUSTRY LTD.

■Feeding Direction

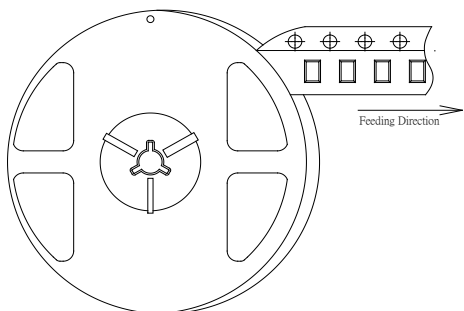

■Dimensions of Tape (Unit: mm)

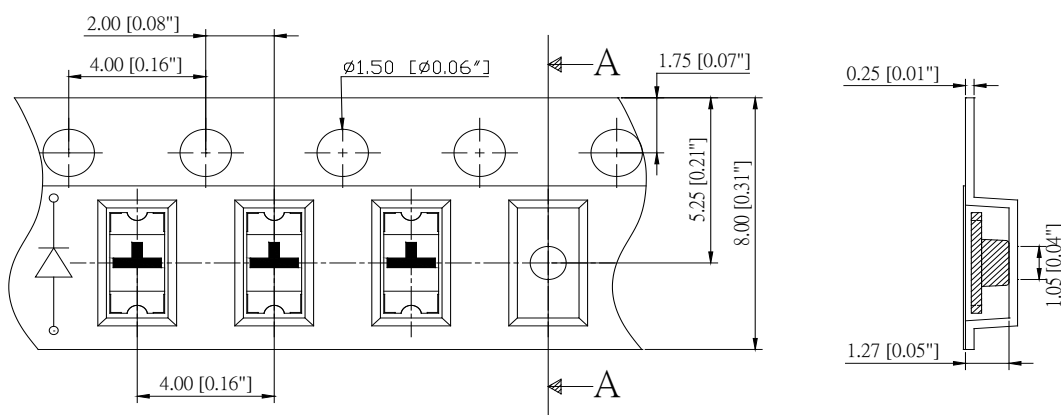

■Arrangement of Tape

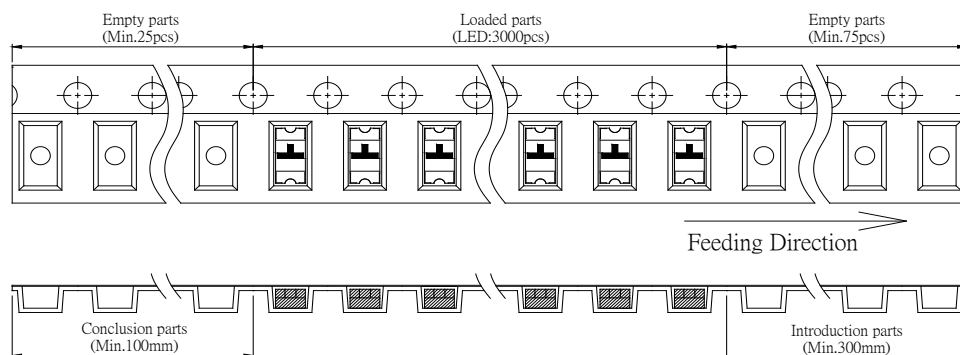

■Note

1. Empty component pockets are sealed with top cover tape;
2. The maximum number of missing lamps is two;
3. The cathode is oriented towards the tape sprocket hole.
4. 3,000 pcs/Reel