



# YETDA INDUSTRY LTD.

## FOUR PINS Super Bright Red LED Lamp Q114LTH4U

Super Bright Red Dice,  
Encapsulated with Water Clear Package.

### Absolute Maximum Ratings :

Parameter	Maximum Rating	Unit
Peak Forward Current	120	mA
Continuous Forward Current	30	mA
Operating Temperature Range	- 20 to + 75	
Storage Temperature Range	- 40 to + 100	
Lead Soldering Temperature	260 for 3 seconds 1.6mm(0.063 inch) from body	

### Electro-Optical Characteristics ( Ta = 25 )

Parameter Radiant	Test Condition	Symbol	Min.	Typ.	Max.	Unit
Forward Voltage	If = 20mA	Vf		2.0	2.4	V
Reverse Current	Vr = 5V	Ir			10	uA
Luminous flux	If = 20mA	Iv	400	600		lm
Spectral Bandwidth	If = 20mA	V				nm
Wavelength	If = 20mA	p	620		625	nm
		d		623		nm
Half View Angle	If = 20mA	2 θ1/2		120		deg

Package

Item: 114

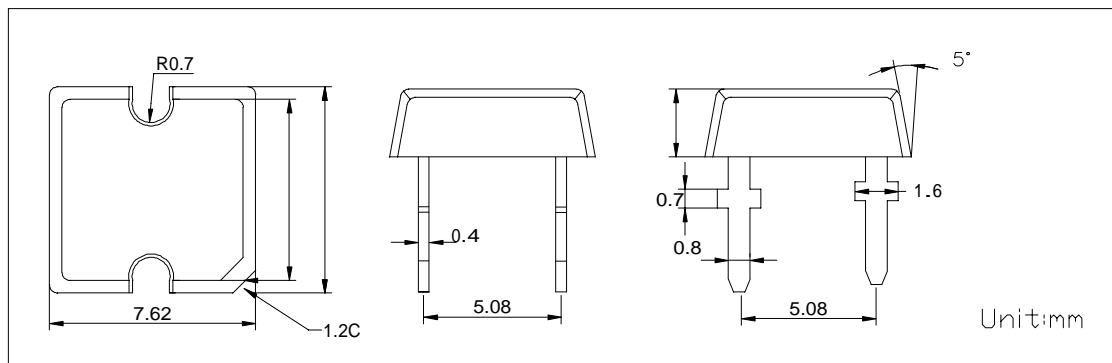

20100428

## ■ Reliability Performance

### Test Items And Result

Test Classification	Test Item	Test Conditions	Test Duration	Sample Size	AC/RE
Life Test	Room Temperature DC Operating Life Test	$T_a=25^{\circ}\text{C}\pm 5^{\circ}\text{C}$ , $I_F=20\text{mA}$	1000 hrs	22 pcs	0/1
Environment Test	Thermal Shock Test	$-10^{\circ}\text{C}\pm 5^{\circ}\text{C}\leftrightarrow +100^{\circ}\text{C}\pm 5^{\circ}\text{C}$ 5min. 10sec. 5min.	50 cycles	22 pcs	0/1
	Temperature Cycle Test	$-40^{\circ}\text{C}\pm 5^{\circ}\text{C}\leftrightarrow +85^{\circ}\text{C}\pm 5^{\circ}\text{C}$ 30min. 5min. 30min.	50 cycles	22 pcs	0/1
	High Temperature & High Humidity Test	$T_a=85^{\circ}\text{C}\pm 5^{\circ}\text{C}$ $\text{RH}=85\%\pm 5\% \text{RH}$	1000 hrs	22 pcs	0/1
	High Temperature Storage	$T_a=100^{\circ}\text{C}\pm 5^{\circ}\text{C}$	1000 hrs	22 pcs	0/1
	Low Temperature Storage	$T_a=-55^{\circ}\text{C}\pm 5^{\circ}\text{C}$	1000 hrs	22 pcs	0/1
Mechanical Test	Resistance to Soldering Heat	$T_a=230^{\circ}\text{C}\pm 5^{\circ}\text{C}$	5sec.	22 pcs	0/1
	Lead Integrity	Load 2.5N(0.25kgf) $0^{\circ} \sim 90^{\circ} \sim 0^{\circ}$	3times	22 pcs	0/1

### Typical Optical/Electrical Characteristics Curves

( $T_a=25^{\circ}\text{C}$  Unless Otherwise Noted)

Forward Current vs. Ambient Temperature    Relative Intensity vs. Ambient Temperature

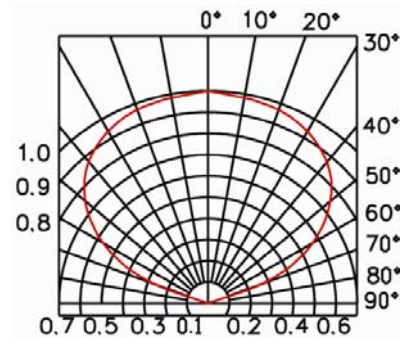
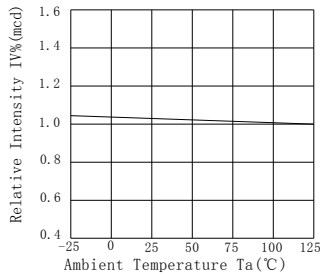
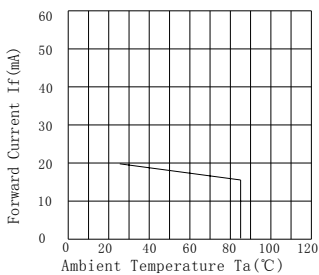

Forward Current vs. Forward Voltage

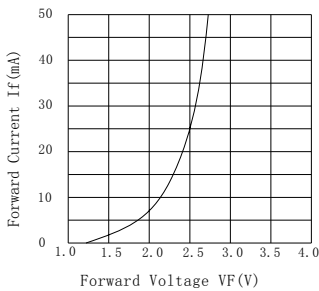

Forward Voltage vs. Ambient Temperature

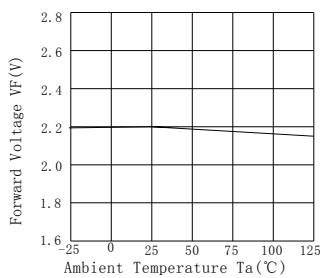

Luminous Spectrum ( $T_a=25^{\circ}\text{C}$ )    SPECTRAL RADIANCE

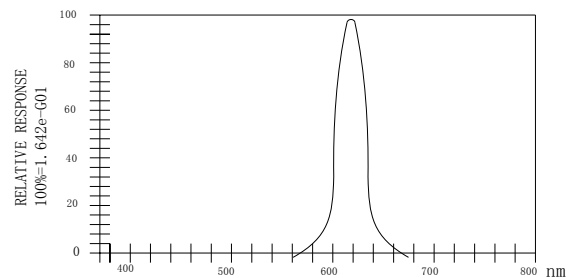

## Package means

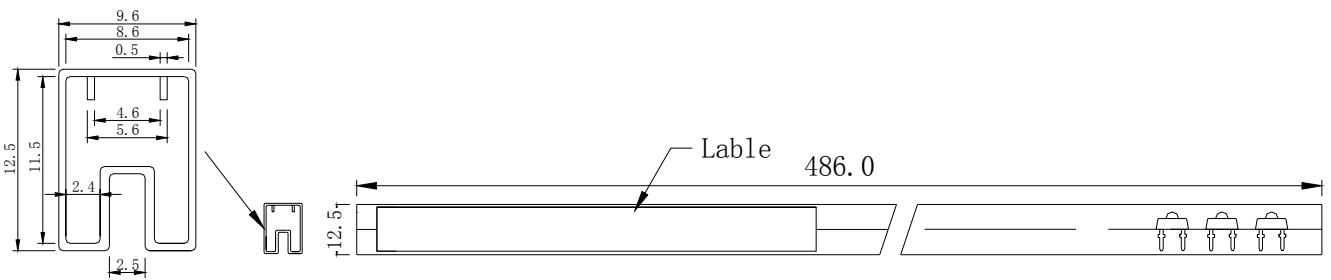

Notes: Each Adhesive Pipe 60pcs.

## Soldering:

### 1. Manual Of Soldering

The temperature of the iron tip should not be higher than 260°C (500°F) and Soldering within 3 seconds per solder-land is to be observed.

### 2. DIP soldering (Wave Soldering):

Preheating: 120°C~150°C, within 120~180 sec.

Operation heating: 245°C ± 5°C within 5 sec. 260°C (Max)

Gradual Cooling (Avoid quenching).

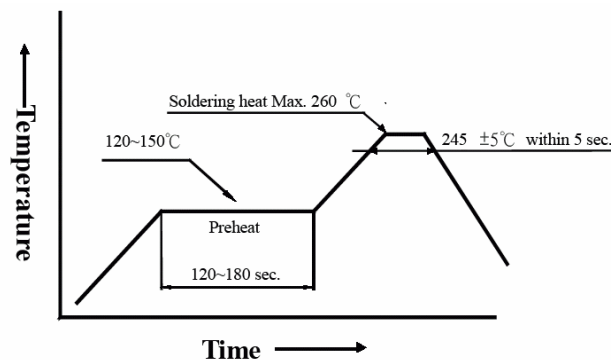

## Handling:

Care must be taken not to cause the epoxy resin portion of LED while it is exposed to high temperature. Care must be taken not to rub the epoxy resin portion of LED with hard or sharp article such as the sand blast and the metal hook.

Care must be taken there should be more than 3mm from jointing point to the epoxy resin.

## Notes for designing:

Care must be taken to provide the current limiting resistor in the circuit so as to drive the LED within the rated figures. Also caution should be taken not to overload LED with exorbitant voltage at the turning ON and OFF of the circuit.

When using the pulse drive care must be taken to keep the average current within the rated figures. Also the circuit should be designed so as to be subjected to reverse voltage when turning off the LED.

## Storage:

In order to avoid the absorption of moisture, it is recommended to solder LED as soon as possible after unpacking the sealed envelope.

If the envelope is still packed to store it in the environment as following:

Temperature: -5°C ~ 45°C (23°F ~ 113°F) Humidity: RH 60% Max.